

Nr					
1	1191	378	15	1	1
2	1191	378	15	1	1
3	1191	378	15	1	1
4	1191	378	15	1	1
5	1225	380	32	1	2
6	387	376	15	6	2
7	1225	380	15	1	2
8	383	383	16	3	2
9	387	387	15	3	1

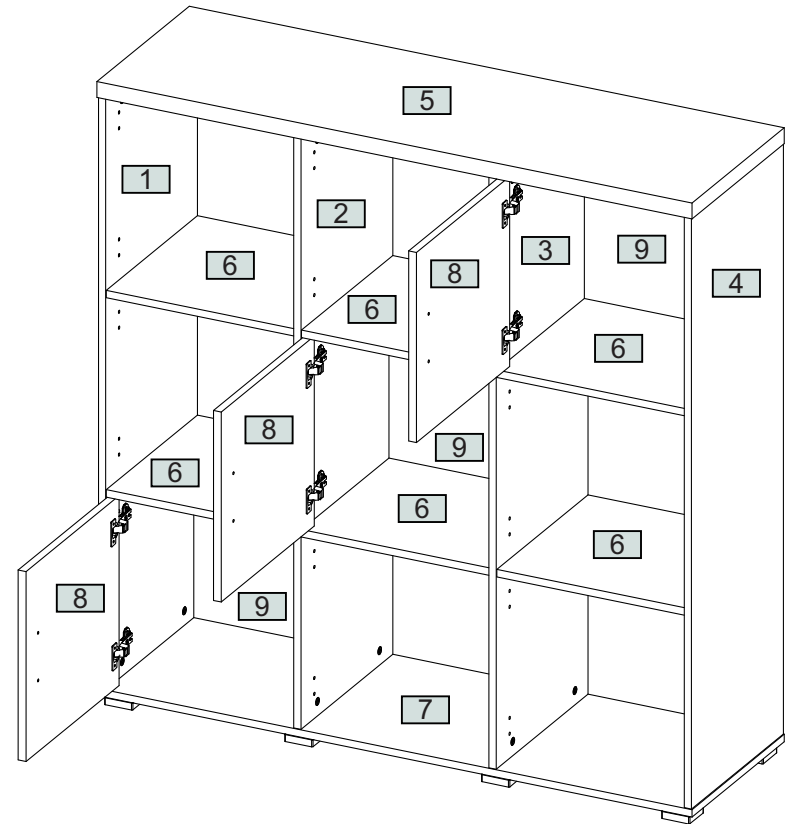

0 10 20 30 40 50 60 70 80 90 100 110 120 130 140 150 160 170 180 190 200



1

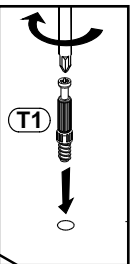
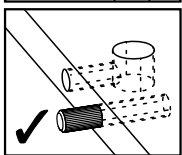
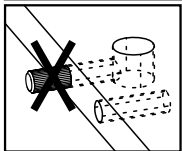
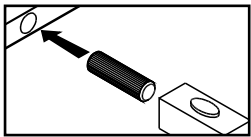
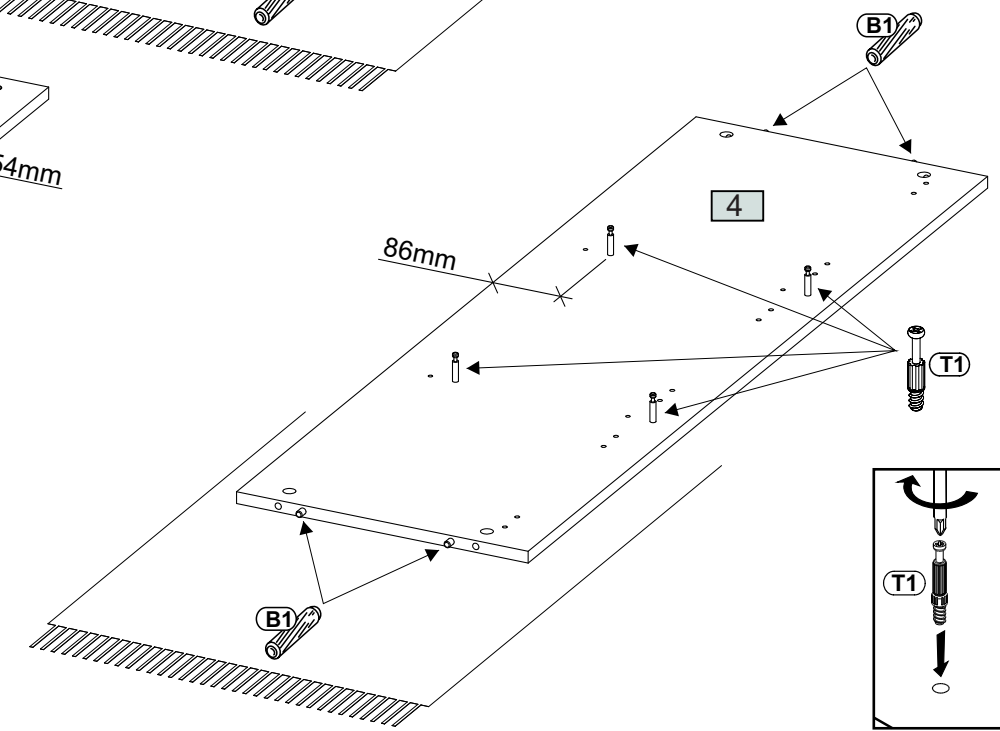
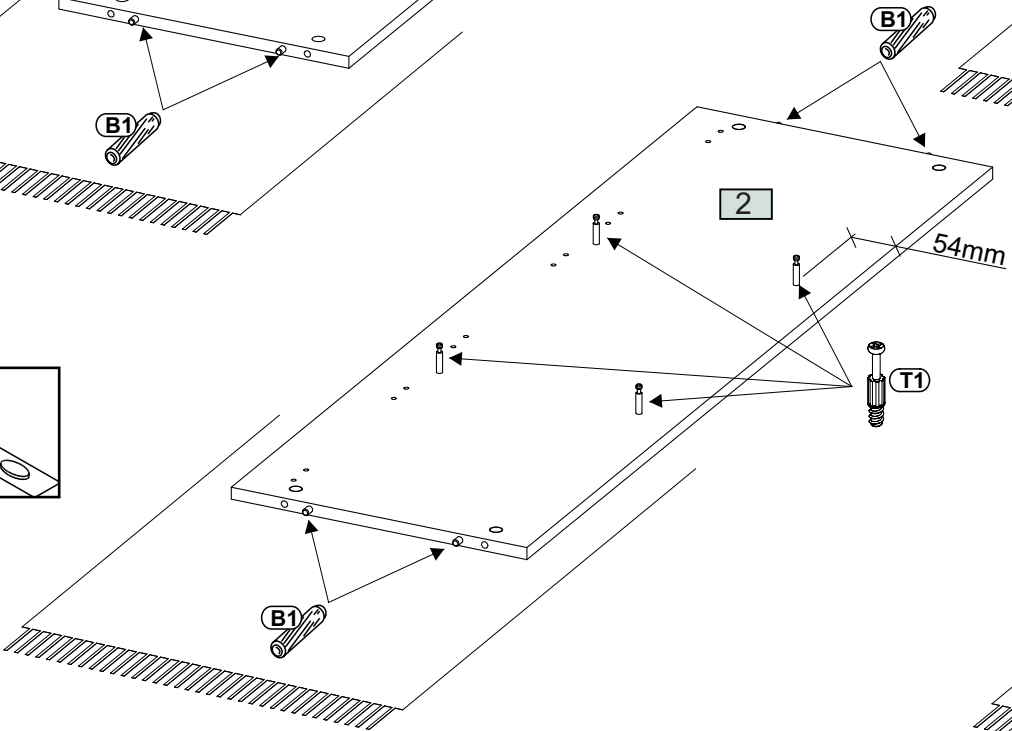
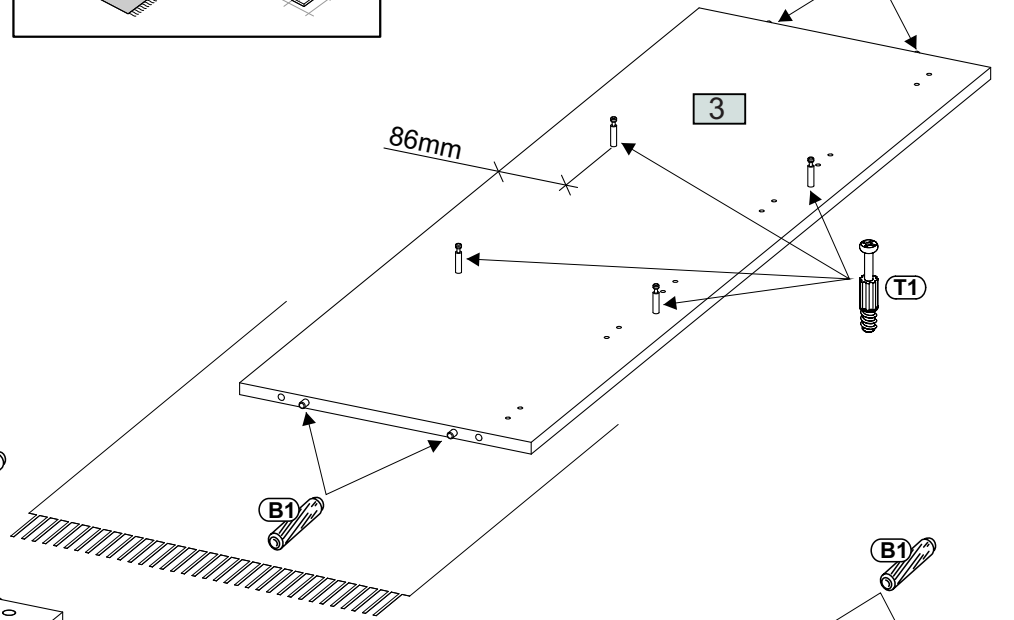
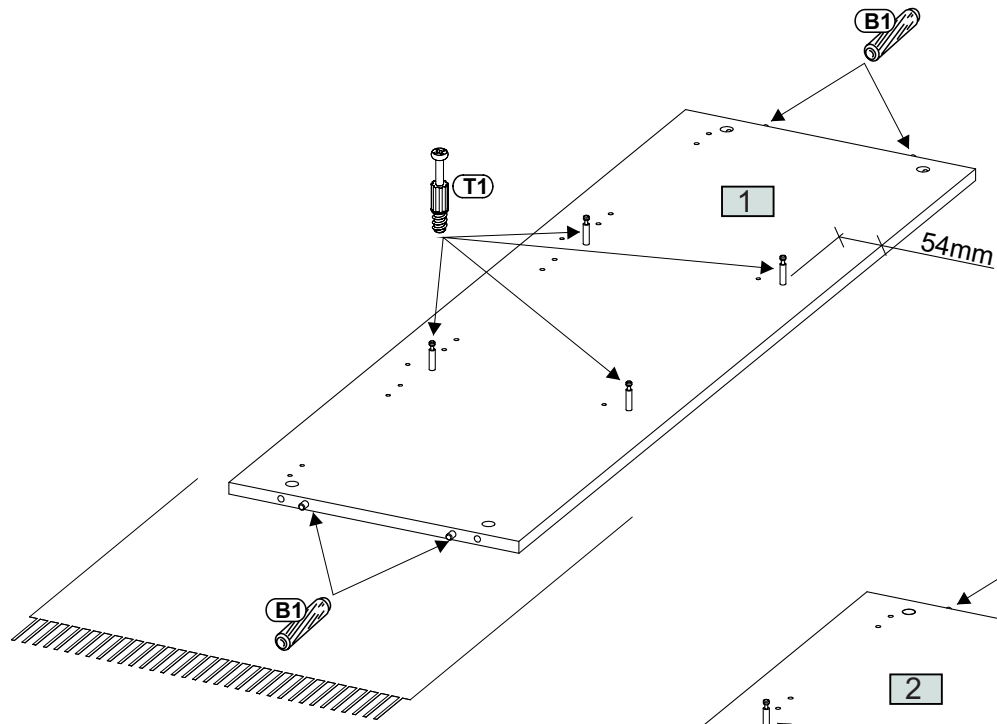
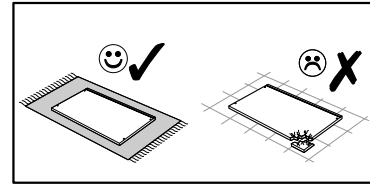
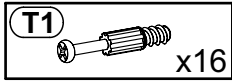
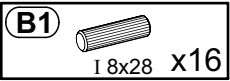

3

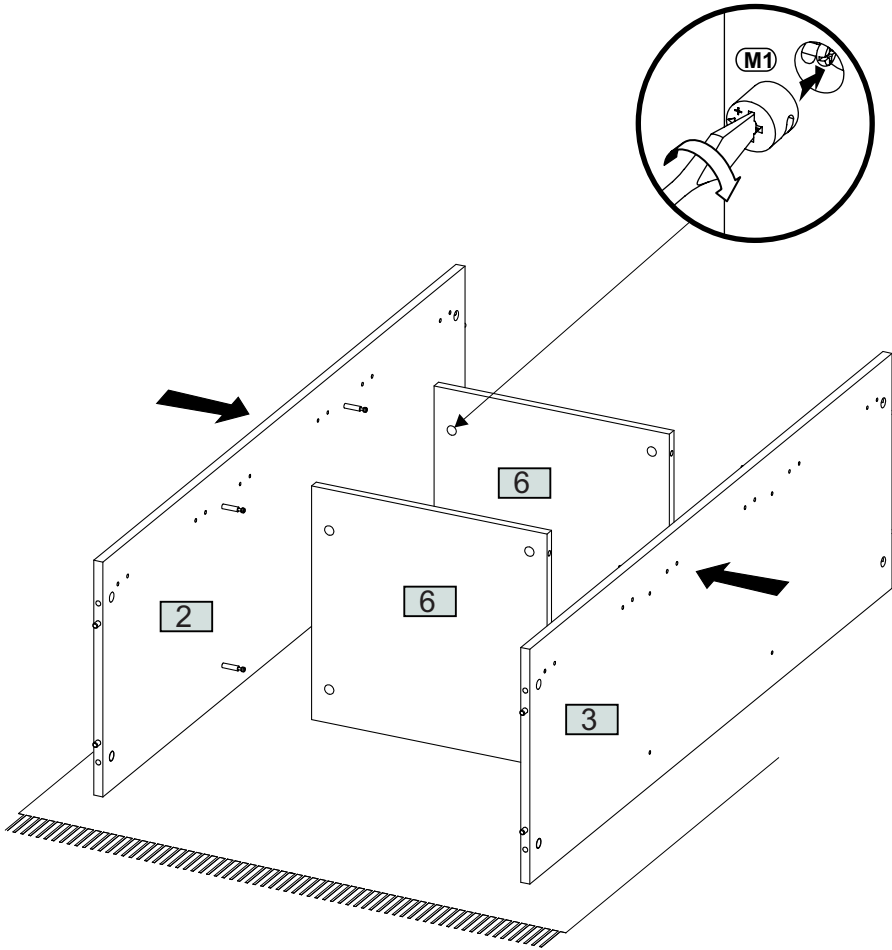
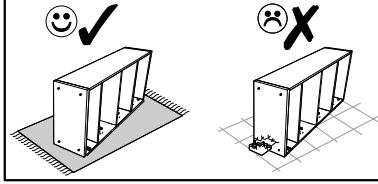

4

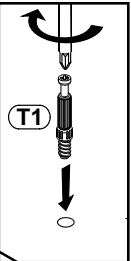
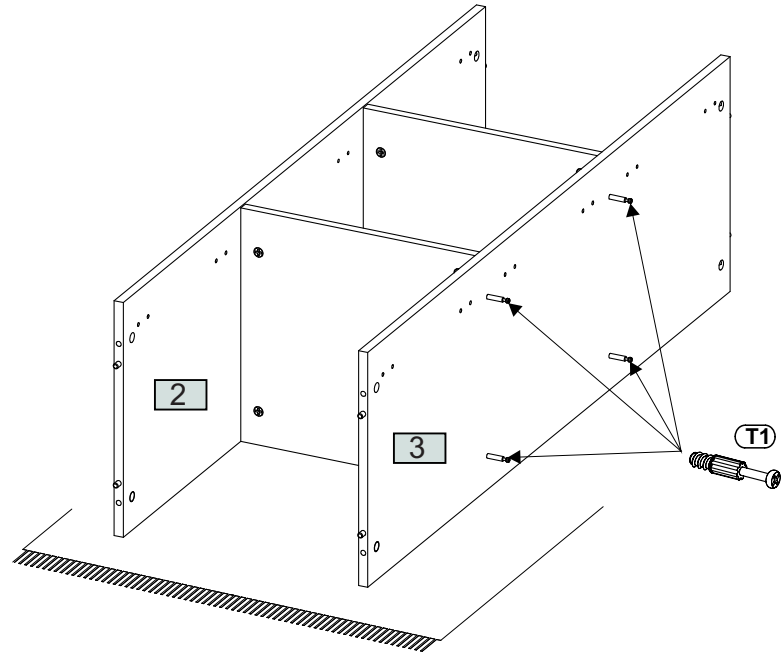
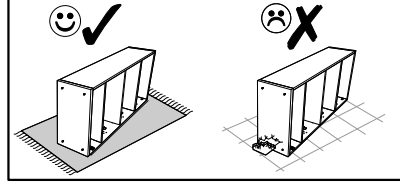
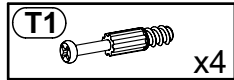

5

M1  x8

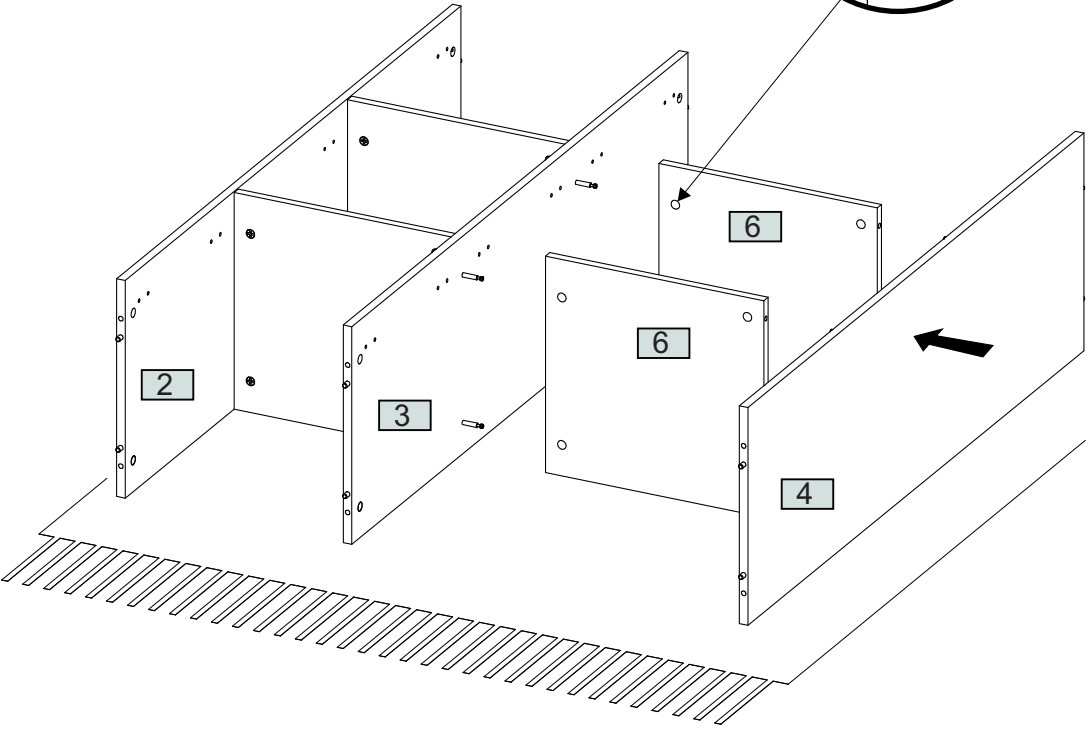
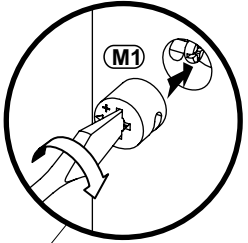
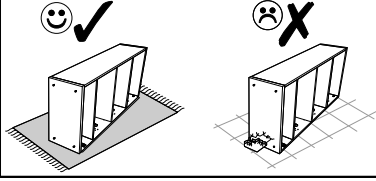

6

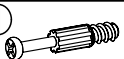
T1  x4

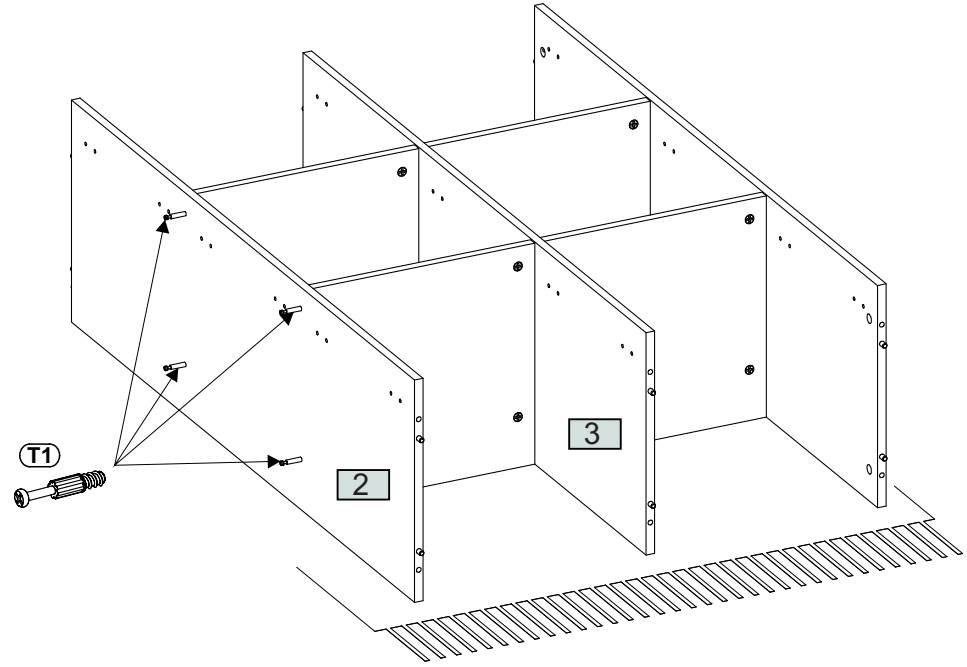
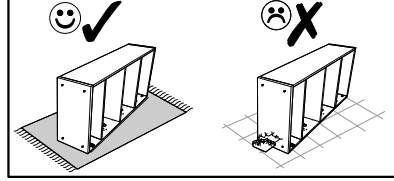

7

M1  x8

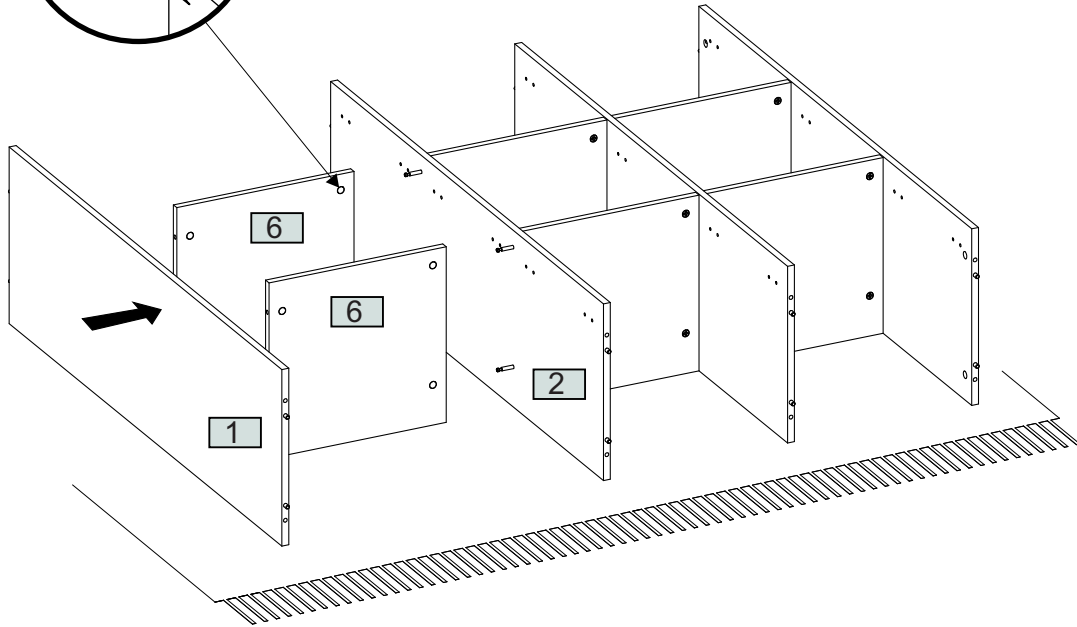
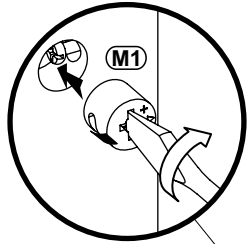
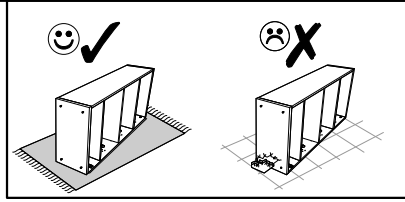

8

M1  x8

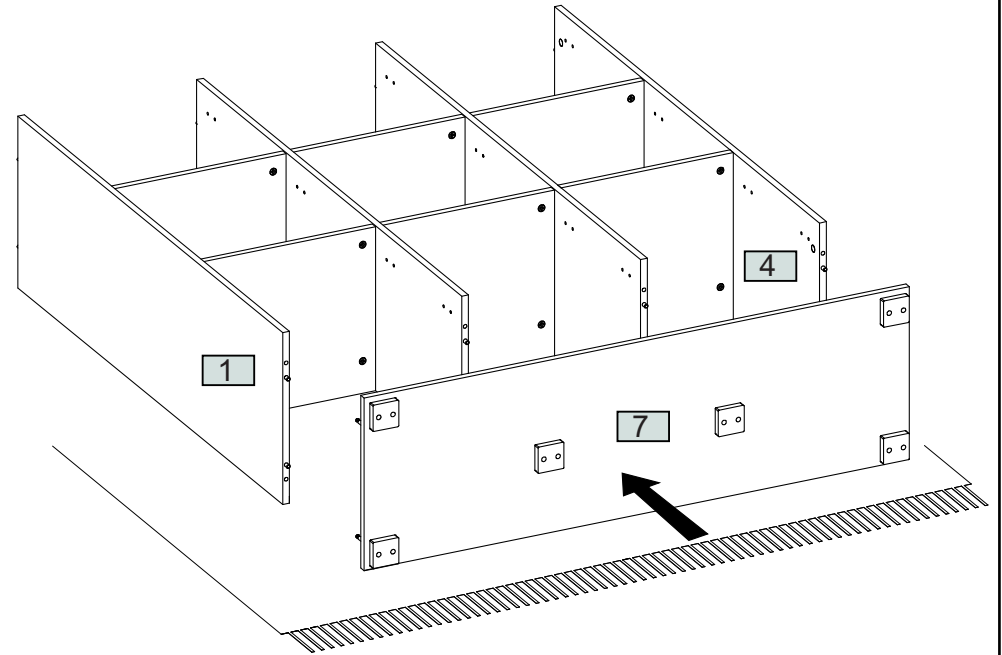
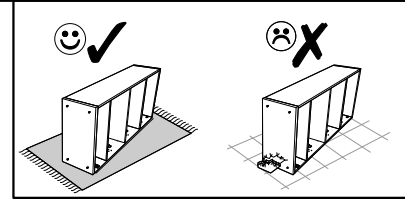

9

M1 x8

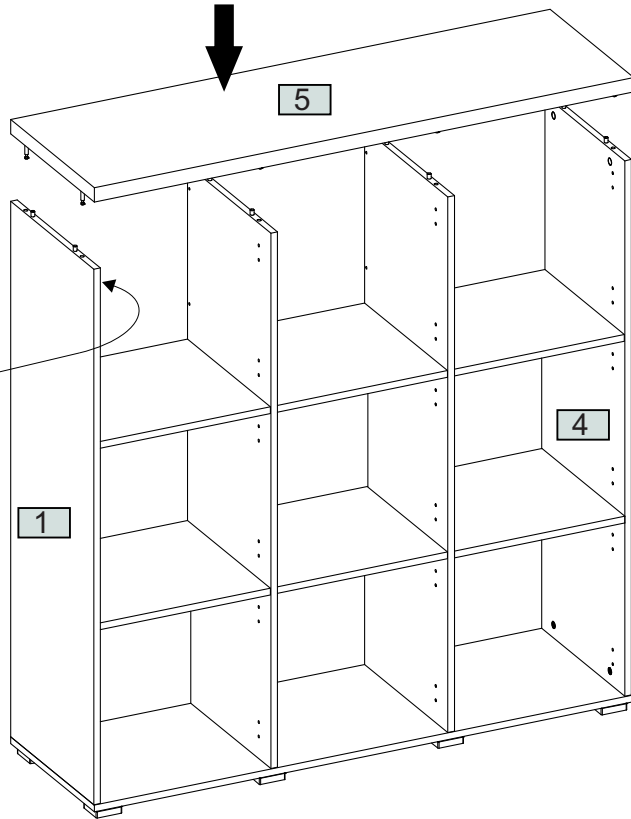
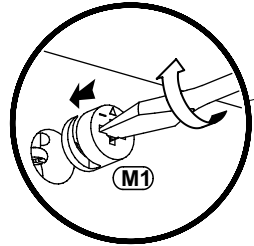
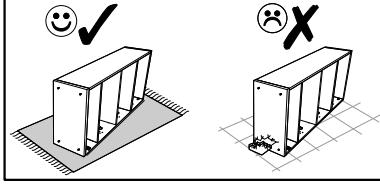

10

X8 x6
S8 4x13 x12

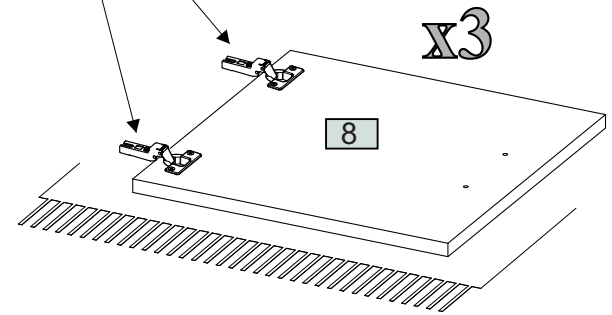
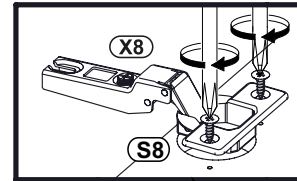
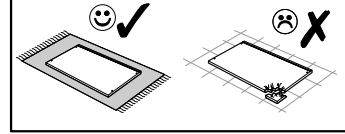

11

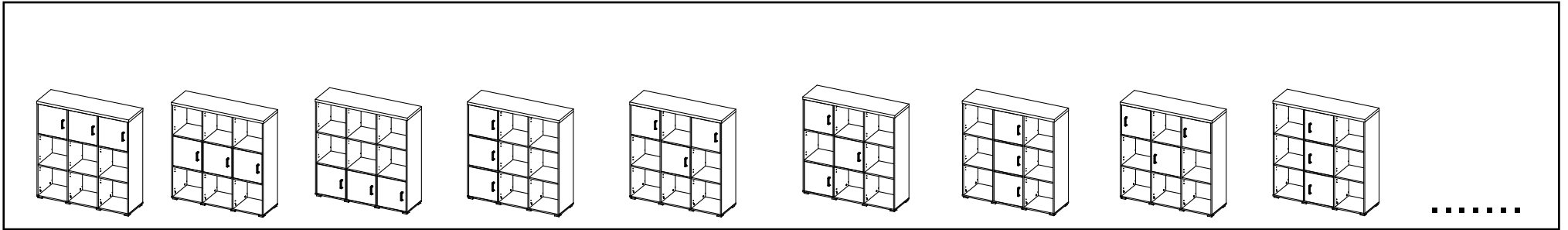
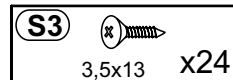
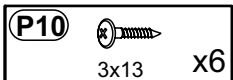
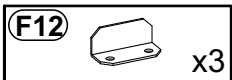
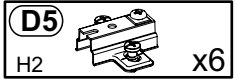

x3

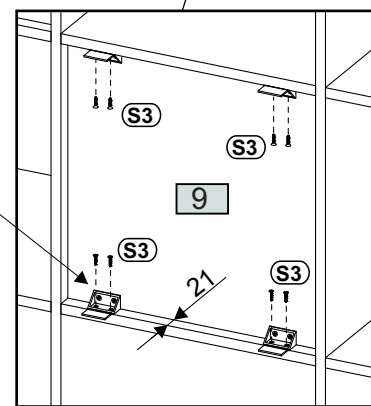
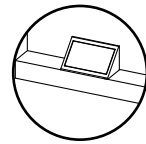
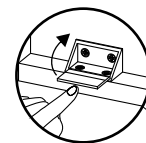
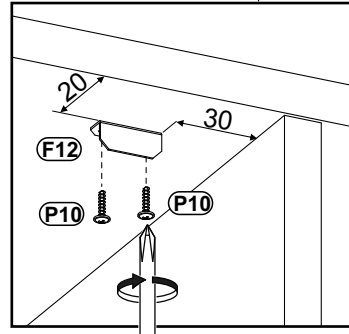
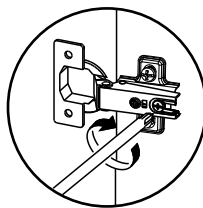
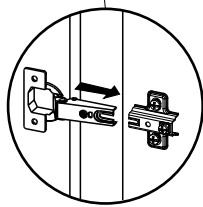
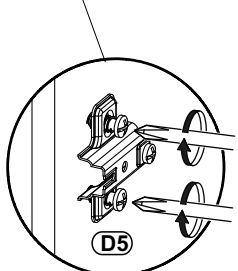
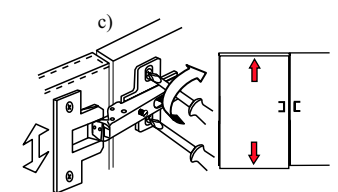
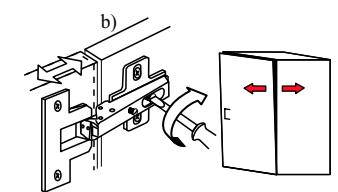
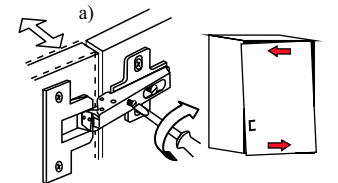
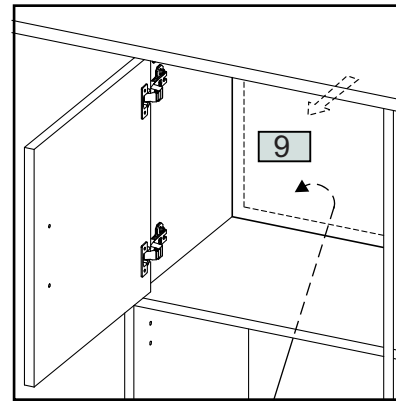
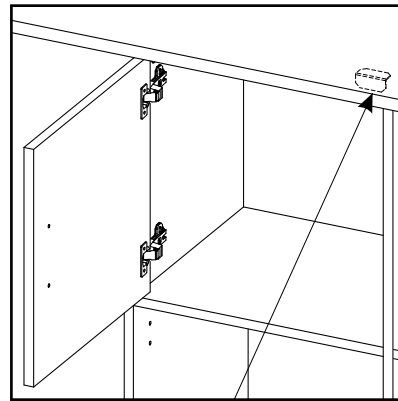
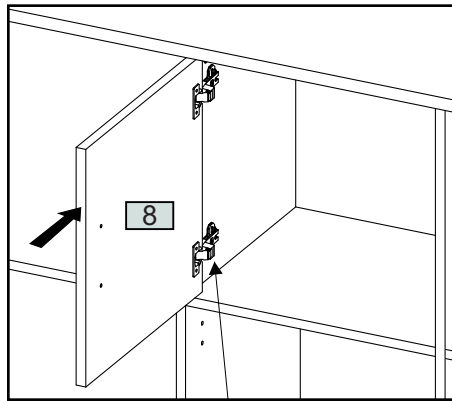
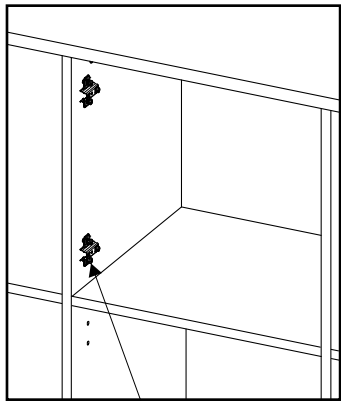

12

- J11** x2
- P13** 3,5x13 x4
- T17** $\phi 8 \times 50$ x2

- U30** x3
- P5** 4x30 x6

